

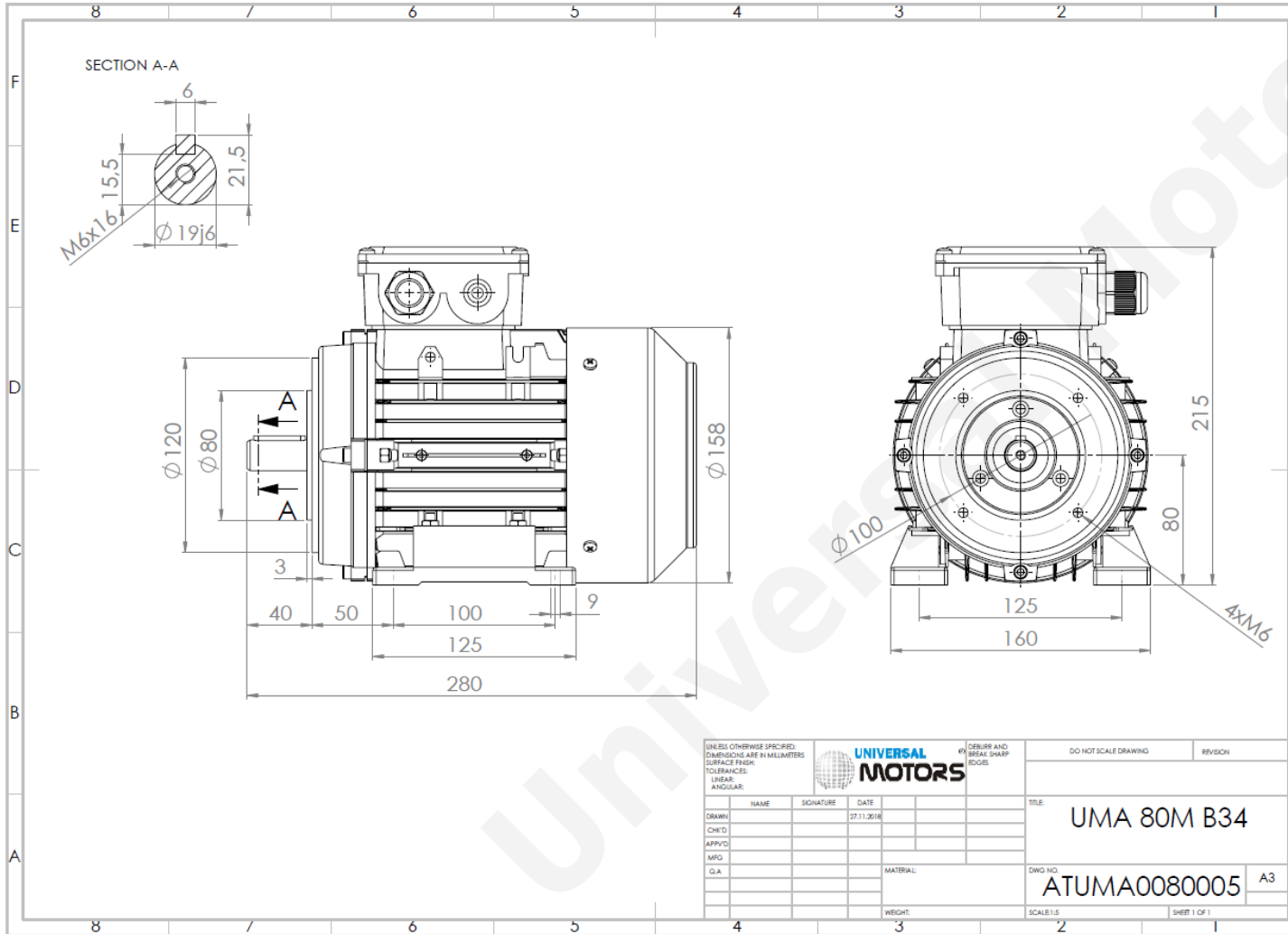

TECHNICAL DATA

Three Phase Electric Motors - Aluminum Frame
 UM2A 80M1-2
 0.75 kW / 1 Cv
 2840 RPM



Motor type:	UM2A 80M1-2
Output:	0.75 kW / 1 Cv
Speed (min ⁻¹):	2840 RPM
Frequency:	50 Hz
Voltage:	400 V
Current:	1.73 A
Power factor (Cos Ø):	0.81
Poles:	2
Insulation class:	F
Temperature rise Class:	B
Efficiency 50%:	75.2 %
Efficiency 75%:	78.0 %
Efficiency 100%:	77.4 %
Torque:	2.5 N.m
Tstarting/Tnominal:	2.6
Istarting/Inominal:	6.1
Tmaximum/Tnominal:	2.8
Noise:	67 Db(A)
Weight:	8.4 Kg
Brake AC:	AC3
Torque Brake DC:	8 N.m
Bearing DE:	6204 2Z
Bearing NDE:	6204 2Z
Torque Brake AC:	15 N.m
Brake DC:	REB-05-08

Regime - S1

Altitude - 1000m

Environment Temperature - 40°C

CONTACTS:

UNIVERSAL MOTORS Tel: +351 252 299 080
 Rua de São Brás,745 Fax: +351 252 299 089
 4480-782 VILA DO CONDE Mail: geral@universalmotors.pt

* References applied only in the UK